

ASANSÖR KABİN VE BİLEŞENLERİ KATALOGU

ELEVATOR CABIN AND COMPONENTS CATALOGUE



Çevreci ve Yeni Nesil
Teknolojik Asansörler

Environmentally Friendly and
New Generation Technological
Elevators



Gemak Asansör bölge sanayisinin gelişimini ve asansör konusunda ki ihtiyacını dikkate alarak 1992 yılında Gebze'de kurulmuştur.

Kurucuları 1982 yılından itibaren asansör ve yürüyen merdiven sektörü içinde kumanda sistemleri, kapı, kabin imalatı, montaj, servis-bakım hizmetleri alanında idareci ve uygulamacı olarak çalışmış bilgi, beceri ve tecrübeleri ile ülkemiz asansör sektörüne ciddi katkı sağlamışlardır. Kurulduğu günden itibaren "En yeni asansör teknolojilerini kullanarak müşterilerine dünya standartlarında çözümler sunmak" ilkesiyle yola çıkan Gemak 41 yıllık süreçte yurt içi ve yurt dışında birçok projeyi başarı ile tamamlayarak ülke sınırlarını aşan firmalardan biri olmayı başarmıştır. 2014 yılında yaptığı yatırımla, 3500 m2'si kapalı olmak üzere 5000 m2 alan üzerine kurduğu Tuzlada fabrikasını faaliyete geçirmiştir.

Müşteri memnuniyetini ön planda tutan GEMAK kısa zaman içerisinde ürün çeşitliliğini, üretim kapasitesini ve müşteri portföyünü genişletmiştir.

GEMAK ,

- Asansörler,
- Yürüyen Merdivenler,
- Engelli Erişim Sistemleri,
- Mekanik-Hidrolik Yük Platformları,

Komple paket asansör sistemleri ve çeşitli asansör ekipmanlarının üretim ve satışında yapmaktadır.

Kurulduğu günden beri müşteri memnuniyetini artırmayı, teknolojik yenilikleri takip ederek modern üretim yapmayı, yurt içi ve yurt dışında pazar payını artırarak ekonomiye katkı sağlamayı hedefleyen GEMAK, ileriki yıllarda ulaştığı bu hedefleri bir üst seviyeye taşımak için, özveriyle çalışmalarını sürdürmektedir.

Gemak Elevator was established in Gebze in 1992, taking into account the development of the regional industry and the need for lifts.

Since 1982, the founders have worked as managers and practitioners in the field of control systems, door, cabin manufacturing, assembly, service-maintenance services in the elevator and escalator sector and have made a significant contribution to the elevator sector of our country with their knowledge, skills and experience. Gemak, which has set out with the principle of "Providing world-class solutions to its customers by using the latest lift technologies" since the day it was founded, has successfully completed many projects in Turkey and abroad in 41 years and has succeeded in becoming one of the companies that exceed the borders of the country. In 2014, with the investment it made in 2014, it put its factory into operation in Tuzla, which was established on an area of 5000 m2, 3500 m2 of which is closed.

GEMAK, which prioritises customer satisfaction, has expanded its product range, production capacity and customer portfolio in a short time.

GEMAK ,

- The Elevators,
- Escalators,
- Disabled Access Systems,
- Mechanical-Hydraulic Load Platforms,

It also manufactures and sells complete package lift systems and various lift equipment.

Since the day it was founded, GEMAK aims to increase customer satisfaction, to make modern production by following technological innovations, to contribute to the economy by increasing its market share both at home and abroad, and continues to work devotedly to carry these targets to the next level in the coming years.



► *İnce detaylarda fark yaratan çarpıcı tasarımlar*

► *Impressive design and elegant details that make*

PROFESSIONAL ELEVATOR SOLUTIONS



İÇİNDEKİLER CONTENTS



KABİNLER

CABINS

KABİNLER	CABINS	
İNSAN ASANSÖRÜ PASLANMAZ KABİNLER	HUMAN LIFT STAINLESS STEEL CABINS	
• Altın renk paslanmaz	• Gold colour stainless	2-6
• Dekoratif desenli paslanmaz	• Decorative patterned stainless	6-11
• Satine paslanmaz	• Satin stainless	12-17
• Satine paslanmaz + Ahşap	• Hairline stainless + Wood	18-19
• Antivandal satine paslanmaz	• Antivandal satin stainless	20
• İTFAİYECİ ASANSÖR KABİNİ PASLANMAZ	• FIRE FIGHTERS CABINS STAINLESS STEEL	21
HASTANE ASANSÖR KABİNLERİ PASLANMAZ	HOSPITAL LIFT CABINS STAINLESS STEEL	
• Satine paslanmaz + Ahşap	• Hairline stainless + Wood	22
• Satine paslanmaz	• Satin stainless	23
• YÜK ASANSÖR KABİNLERİ PASLANMAZ	• FREIGHT LIFT CABINS STAINLESS STEEL	
• Satine paslanmaz	• Satin stainless	24-25
• SERVİS ASANSÖR KABİNİ PASLANMAZ	• SERVICE LIFT CABINS STAINLESS STEEL	26
AHŞAP MASİF KABİNLER	WOODEN MASSIVE CABINS	
• Masif ahşap	• Solid wood	27
• Laminat	• Laminate	28-44
CAM KABİNLER	GLASS CABINS	
• Düz cam	• Flat glass	45-52
• Desenli cam	• Patterned glass	53-54
• Panoramik	• Panoramic	55-60
ELEKTROSTATİK RALL BOYALI İNSAN ASANSÖRÜ KABİNLERİ	EPOXY POWDER PAINTED LIFT CABINS	
• Tek düz renk	• Single solid colour	61-62
• Çift düz renk	• Double solid colour	63
• Antivandal	• Antivandal	64
• İTFAİYECİ ASANSÖR KABİNİ ELEKTROSTATİK BOYALI	• FIRE FIGHTERS CABINS EPOXY POWDER PAINTED	65
• YÜK ASANSÖR KABİNLERİ ELEKTROSTATİK BOYALI	• FREIGHT LIFT CABINS EPOXY POWDER PAINTED	66-67
• SERVİS ASANSÖR KABİNİ ELEKTROSTATİK BOYALI	• SERVICE LIFT CABINS EPOXY POWDER PAINTED	68
KABİN KARKASLARI	CAR FRAME	69
• HİDROLİK L TİP KARKAS	• HYDRAULIC L TYPE CAR FRAME	70
• HİDROLİK TANDEM TİP KARKAS	• HYDRAULIC TANDEM TYPE CAR FRAME	71
• KARŞI AĞIRLIK KARKASI 1/1 - 1/2 TEK SIRA	• WEIGHT FRAME 1/1 - 1/2 SINGLE ROW	72
• KARŞI AĞIRLIK KARKASI 1/2 ÇİFT SIRA	• WEIGHT FRAME 1/2 DOUBLE ROW	73
• KAYMA FREN SEÇENEKLERİ	• PROGRESSIVE SAFETY GEARS	74
• TAVAN SEÇENEKLERİ	• CELLING OPTIONS	75-76
• TABAN ZEMİN SEÇENEKLERİ	• FLOOR (GROUND) OPTIONS	77
• PASLANMAZ SEÇENEKLERİ	• STAINLESS OPTIONS	78
• LAMİNAT SEÇENEKLERİ	• LAMINATE OPTIONS	79
• RALL BOYA SEÇENEKLERİ	• RALL PAINT OPTIONS	80
• KÜPEŞTE (TUTAMAK) SEÇENEKLERİ	• HANDRAIL (HANDLE) OPTIONS	81
• ÇARPMA BANDI SEÇENEKLERİ	• BUMPER RAIL OPTIONS	82
KOMPLE ASANSÖR SİSTEMLERİ	COMPLATE ELEVATOR SYSTEMS	
• MR Sistem (Makine Daireli Sistem)	• MR Systems (Machine Room Systems)	25
• MRL Sistem (Makine Dairesiz Sistem)	• MRL Systems (Machine Roomless Systems)	26
• Hidrolik Sistem	• Hydraulic Lift Systems	27
• Servis Asansörleri	• Dumpwaiter Service Elevators	28

451



GOLD



DETAYLAR

- Kabin İçi Kaplama : Laminant + Özel Desen + Dekoratif
Kabin İçi Aksesuar : Pslz. Dekoratif Paslanmaz
Kabin İçi Tavan : Lazer Kesim
Kabin İçi Taban : Granit
Kabin İçi Ayna Şekli : Tam Boy

DETAILS

- Cabin Coating : Laminate+ Special Design + Decorative Stainless
Cabin Accessories : Decorative Stainless Steel
Cabin Ceiling : Laser Cut
Cabin Floor : Granite
Cabin Mirror : Full Height

PROFESSIONAL ELEVATOR SOLUTIONS

G150



ZEOS

GOLD

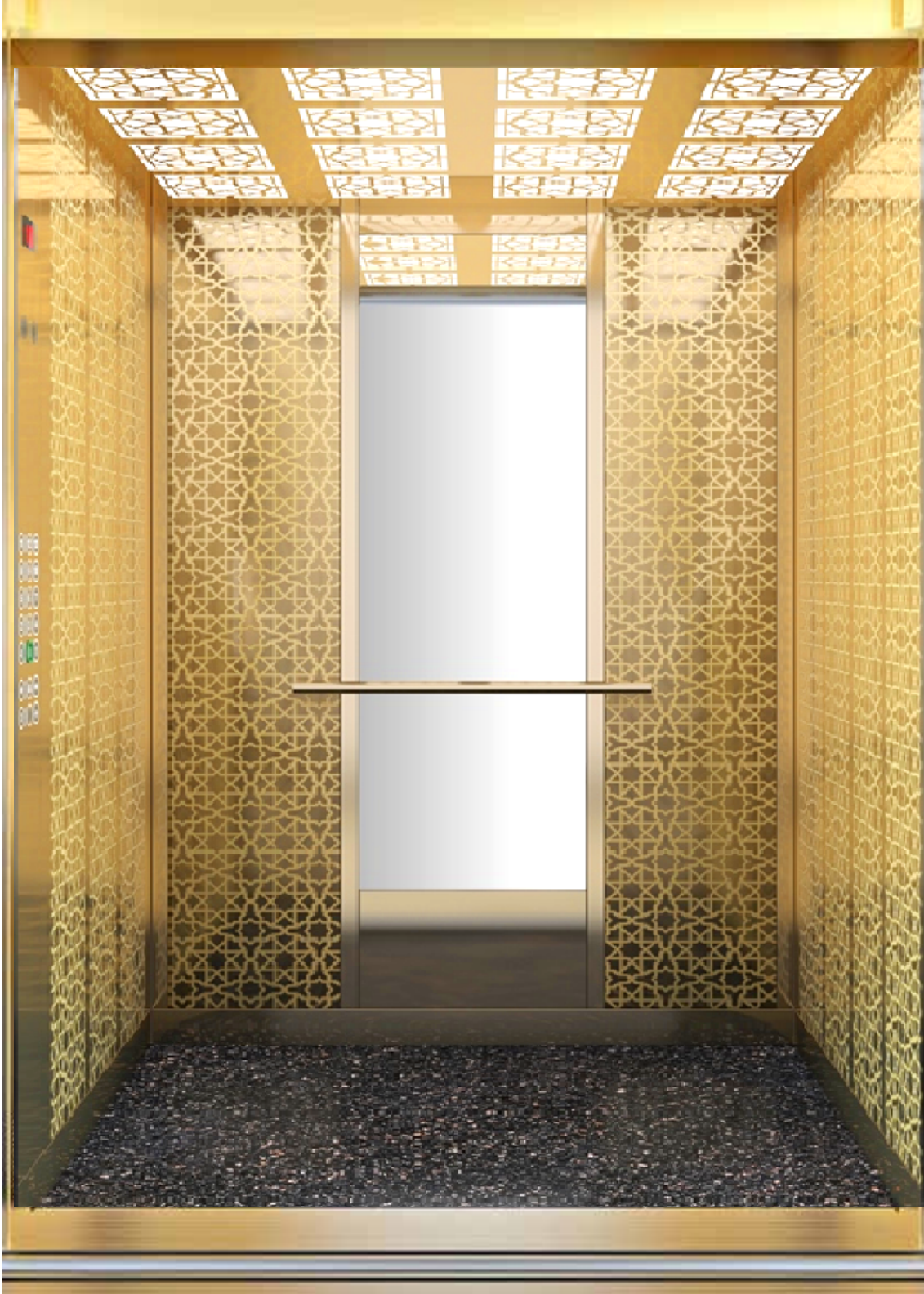

DETAYLAR

- Kabin İçi Kaplama : Laminant + Özel Desen + Dekoratif
Kabin İçi Aksesuar : Pslz. Dekoratif Paslanmaz
Kabin İçi Tavan : Lazer Kesim
Kabin İçi Taban : Granit
Kabin İçi Ayna Şekli : Tam Boy

DETAILS

- Cabin Coating : Laminate+ Special Design + Decorative Stainless
Cabin Accessories : Decorative Stainless Steel
Cabin Ceiling : Laser Cut
Cabin Floor : Granite
Cabin Mirror : Full Height

PROFESSIONAL ELEVATOR SOLUTIONS

452



GOLD



DETAYLAR

- Kabin İçi Kaplama : Dekoratif Paslanmaz
Kabin İçi Aksesuar : Dekoratif Paslanmaz
Kabin İçi Tavan : Özel Tasarım + Arka Led Aydınlatma
Kabin İçi Taban : Granit
Kabin İçi Ayna Şekli : Tam Boy + Arka Led Aydınlatma

DETAILS

- Cabin Coating : Decorative Stainless Steel
Cabin Accessories : Decorative Stainless Steel
Cabin Ceiling : Special Design + Behind Led
Cabin Floor : Light Granite
Cabin Mirror : Full Height + Behind Led Light

PROFESSIONAL ELEVATOR SOLUTIONS

453



GOLD



DETAYLAR

- Kabin İçi Kaplama : Dekoratif Paslanmaz
Kabin İçi Aksesuar : Dekoratif Paslanmaz
Kabin İçi Tavan : Lazer Kesim
Kabin İçi Taban : Granit
Kabin İçi Ayna Şekli : Yarım Boy

DETAILS

- Cabin Coating : Decorative Stainless Steel
Cabin Accessories : Decorative Stainless Steel
Cabin Ceiling : Laser Cut
Cabin Floor : Granite
Cabin Mirror : Half Height

PROFESSIONAL ELEVATOR SOLUTIONS

454



GOLD



DETAYLAR

- Kabin İçi Kaplama : Dekoratif Paslanmaz
Kabin İçi Aksesuar : Dekoratif Paslanmaz
Kabin İçi Tavan : Lazer Kesim
Kabin İçi Taban : Granit
Kabin İçi Ayna Şekli : Yarım Boy

DETAILS

- Cabin Coating : Decorative Stainless Steel
Cabin Accessories : Decorative Stainless Steel
Cabin Ceiling : Laser Cut
Cabin Floor : Granite
Cabin Mirror : Half Height

PROFESSIONAL ELEVATOR SOLUTIONS

**DETAYLAR**

Kabin İçi Kaplama	: Dekoratif Paslanmaz
Kabin İçi Aksesuar	: Ayna Paslanmaz
Kabin İçi Tavan	: Lazer Kesim
Kabin İçi Taban	: Granit
Kabin İçi Ayna Şekli	: Tam Boy

DETAILS

Cabin Coating	:Decorative Stainless Steel
Cabin Accessories	:Mirror Stainless Steel
Cabin Ceiling	:Laser Cut
Cabin Floor	:Granite
Cabin Mirror	:Full Height

**DETAYLAR**

Kabin İçi Kaplama	: Dekoratif Paslanmaz
Kabin İçi Aksesuar	: Satine Paslanmaz
Kabin İçi Tavan	: Lazer Kesim
Kabin İçi Taban	: Granit
Kabin İçi Ayna Şekli	: Tam Boy

DETAILS

Cabin Coating	: Decorative Stainless Steel
Cabin Accessories	: Satinated Stainless Steel
Cabin Ceiling	: Laser Cut
Cabin Floor	: Granite
Cabin Mirror	: Full Height

**DETAYLAR**

- Kabin İçi Kaplama : Nokta Desen Paslanmaz
Kabin İçi Aksesuar : Satine Paslanmaz
Kabin İçi Tavan : Lazer Kesim
Kabin İçi Taban : Granit
Kabin İçi Ayna Şekli : Tam Boy

DETAILS

- Cabin Coating : Linen Pattern Stainless Steel
Cabin Accessories : Satinated Stainless Steel
Cabin Ceiling : Laser Cut
Cabin Floor : Granite
Cabin Mirror : Full Height

**DETAYLAR**

- Kabin İçi Kaplama : Dekoratif Paslanmaz
 Kabin İçi Aksesuar : Dekoratif Paslanmaz
 Kabin İçi Tavan : Özel Tasarım + Arka Led
 Kabin İçi Taban : Aydınlatma Granit
 Kabin İçi Ayna Şekli : Tam Boy + Arka Led Aydınlatma

DETAILS

- Cabin Coating : Decorative Stainless Steel
 Cabin Accessories : Decorative Stainless Steel
 Cabin Ceiling : Special Design + Behind Led
 Cabin Floor : Light Granite
 Cabin Mirror : Full Height + Behind Led Light

G140



KANON

CROME



DETAYLAR

- Kabin İçi Kaplama : Dekoratif Mozaik Desen Paslanmaz
Kabin İçi Aksesuar : Satine Paslanmaz
Kabin İçi Tavan : Lazer Kesim
Kabin İçi Taban : Granit
Kabin İçi Ayna Şekli : Tam Boy

DETAILS

- Cabin Coating : Decorative Mosaic Pattern Stainless
Cabin Accessories : Satinated Stainless Steel
Cabin Ceiling : Laser Cut
Cabin Floor : Granite
Cabin Mirror : Full Height

PROFESSIONAL ELEVATOR SOLUTIONS

G110



KURUMSAL

CROME



PROFESSIONAL ELEVATOR SOLUTIONS

DETAYLAR

Kabin İçi Kaplama	: Satine Paslanmaz
Kabin İçi Aksesuar	: Satine Paslanmaz
Kabin İçi Tavan	: Lazer Kesim
Kabin İçi Taban	: Granit
Kabin İçi Ayna Şekli	: Tam Boy

DETAILS

Cabin Coating	: Satinated Stainless Steel
Cabin Accessories	: Satinated Stainless Steel
Cabin Ceiling	: Laser Cutazer
Cabin Floor	: Granite
Cabin Mirror	: Full Height

G110



EKOZA

CROME



DETAYLAR

Kabin İçi Kaplama	: Satine Paslanmaz
Kabin İçi Aksesuar	: Satine Paslanmaz
Kabin İçi Tavan	: Lazer Kesim
Kabin İçi Taban	: Granit
Kabin İçi Ayna Şekli	: Tam Boy

DETAILS

Cabin Coating	: Satinated Stainless Steel
Cabin Accessories	: Satinated Stainless Steel
Cabin Ceiling	: Laser Cutazer
Cabin Floor	: Granite
Cabin Mirror	: Full Height

PROFESSIONAL ELEVATOR SOLUTIONS

320



CROME



DETAYLAR

- Kabin İçi Kaplama : Satine Paslanmaz
Kabin İçi Aksesuar : Satine Paslanmaz
Kabin İçi Tavan : Özel Tasarım + Spot Aydınlatma
Kabin İçi Taban : Granit
Kabin İçi Ayna Şekli : Tam Boy

DETAILS

- Cabin Coating : Satinated Stainless Steel
Cabin Accessories : Satinated Stainless Steel
Cabin Ceiling : Special Design + Spot Light
Cabin Floor : Granite
Cabin Mirror : Full Height

PROFESSIONAL ELEVATOR SOLUTIONS



DETAYLAR

Kabin İçi Kaplama	: Satine Paslanmaz
Kabin İçi Aksesuar	: Ayna Paslanmaz
Kabin İçi Tavan	: Özel Tasarım + Arka Led Aydınlatma
Kabin İçi Taban	: Granit
Kabin İçi Ayna Şekli	: Tam Boy + Arka Led Aydınlatma

DETAILS

Cabin Coating	:Satinated Stainless Steel
Cabin Accessories	:Mirror Stainless Steel
Cabin Ceiling	:Special Design + Behind Led Light
Cabin Floor	:Granite
Cabin Mirror	:Full Height + Behind Led Light

**DETAYLAR**

Kabin İçi Kaplama	: Satine Paslanmaz
Kabin İçi Aksesuar	: Ayna Paslanmaz
Kabin İçi Tavan	: Lazer Kesim
Kabin İçi Taban	: Granit
Kabin İçi Ayna Şekli	: Tam Boy

DETAILS

Cabin Coating	:Satinated Stainless Steel
Cabin Accessories	:Mirror Stainless Steel
Cabin Ceiling	:Laser Cut
Cabin Floor	:Granite
Cabin Mirror	:Full Height

**DETAYLAR**

Kabin İçi Kaplama	: Satine Paslanmaz
Kabin İçi Aksesuar	: Satine Paslanmaz
Kabin İçi Tavan	: Özel Tasarım
Kabin İçi Taban	: Granit
Kabin İçi Ayna Şekli	: Tam Boy

DETAILS

Cabin Coating	: Satinated Stainless Steel
Cabin Accessories	: Satinated Stainless Steel
Cabin Ceiling	: Special Design
Cabin Floor	: Granite
Cabin Mirror	: Full Height

**DETAYLAR**

Kabin İçi Kaplama	: Satine Paslanmaz
Kabin İçi Aksesuar	: Ayna Paslanmaz
Kabin İçi Tavan	: Lazer Kesim + Spot
Kabin İçi Taban	: Aydınlatma Granit
Kabin İçi Ayna Şekli	: Tam Boy

DETAILS

Cabin Coating	:Satinated Stainless Steel
Cabin Accessories	:Mirror Stainless Steel
Cabin Ceiling	:Laser Cut + Spot Light
Cabin Floor	:Granite
Cabin Mirror	:Full Height

G200



KARMA

CROME



PROFESSIONAL ELEVATOR SOLUTIONS

DETAYLAR

- Kabin İçi Kaplama : Satine Paslanmaz + Laminat
Kabin İçi Aksesuar : Ayna Paslanmaz
Kabin İçi Tavan : Lazer Kesim
Kabin İçi Taban : Granit
Kabin İçi Ayna Şekli : Tam Boy

DETAILS

- Cabin Coating :Satinated Stainless Steel + Laminat
Cabin Accessories :Mirror Stainless Steel
Cabin Ceiling :Laser Cut
Cabin Floor :Granite
Cabin Mirror :Full Height

**DETAYLAR**

Kabin İçi Kaplama	: Satine Paslanmaz + Laminat Ayna
Kabin İçi Aksesuar	: Paslanmaz
Kabin İçi Tavan	: Lazer Kesim
Kabin İçi Taban	: Granit
Kabin İçi Ayna Şekli	: Tam Boy + Arka Led Aydınlatma

DETAILS

Cabin Coating	:Satinated Stainless Steel + Laminate
Cabin Accessories	:Mirror Stainless Steel
Cabin Ceiling	:Laser Cut
Cabin Floor	:Granite
Cabin Mirror	:Full Height + Behind Led Light



DETAYLAR

Kabin İçi Kaplama	: Satine Paslanmaz
Kabin İçi Aksesuar	: Satine Paslanmaz
Kabin İçi Tavan	: Satine Paslanmaz + Led Aydınlatma+IP54
Kabin İçi Taban	: Alüminyum Çeta Desen
Kabin İçi Ayna Şekli	: Tam Boy

DETAILS

Cabin Coating	: Satin Stainless Steel
Cabin Accessories	: Satin Stainless Steel
Cabin Ceiling	: Satin Stainless Steel + Led Light + IP 54
Cabin Floor	: Aluminum Checkered Pattern
Cabin Mirror	: Full Height

İTFAİYECİ KABİNİ

FIRE FIGHTERS LIFT CAR

310



EN 81 - 72

CROME



PROFESSIONAL ELEVATOR SOLUTIONS

DETAYLAR

Kabin İçi Kaplama	: Satinated Paslanmaz
Kabin İçi Aksesuar	: Satinated Paslanmaz
Kabin İçi Tavan	: IP-54 Led Aydınlatma
Kabin İçi Taban	: Alüminyum Çeta Desen
Kabin İçi Ayna Şekli	: Yok

DETAILS

Cabin Coating	: Satinated Stainless Steel
Cabin Accessories	: Satinated Stainless Steel IP-54
Cabin Ceiling	: Led Light
Cabin Floor	: Aluminum Chequered Pattern
Cabin Mirror	: None

SEDYE ASANSÖRÜ

HOSPITAL ELEVATOR

390



CROME



DETAYLAR

- Kabin İçi Kaplama : Satine Paslanmaz
Kabin İçi Aksesuar : Satine Paslanmaz + Laminant Özel
Kabin İçi Tavan : Tasarım + Led Aydınlatma PVC -
Kabin İçi Taban : Anti Bacterial
Kabin İçi Ayna Şekli : Yok

DETAILS

- Cabin Coating : Satin Stainless Steel
Cabin Accessories : Satin Stainless Steel + Laminant Special
Cabin Ceiling : Design + Led Light
Cabin Floor : PVC - Antibakteriyel
Cabin Mirror : None

PROFESSIONAL ELEVATOR SOLUTIONS

SEDYE ASANSÖRÜ

HOSPITAL ELEVATOR

G600



CROME



PROFESSIONAL ELEVATOR SOLUTIONS

DETAYLAR

- Kabin İçi Kaplama : Satine Paslanmaz
Kabin İçi Aksesuar : Satine Paslanmaz
Kabin İçi Tavan : Özel Tasarım + Led
Kabin İçi Taban : PVC - Anti Bacterial
Kabin İçi Ayna Şekli : Arka duvarda yarım boy

DETAILS

- Cabin Coating : Satin Stainless Steel
Cabin Accessories : Satin Stainless Steel
Cabin Ceiling : Special Design + Led Light
Cabin Floor : PVC - Antibakteriyel
Cabin Mirror : Half height on the back wall



CROM



PROFESSIONAL ELEVATOR SOLUTIONS

DETAYLAR

- Kabin İçi Kaplama : Satine Paslanmaz Duvarlar
Kabin İçi Aksesuar : Satine Paslanmaz
Kabin İçi Tavan : Satine Paslanmaz + Led Aydınlatma
Kabin İçi Taban : Baklava Desenli Galvanize Sac
Kabin İçi Ayna Şekli : Yok

DETAILS

- Cabin Coating : Epoxy Powder Painted Wall
Cabin Accessories : Epoxy Powder Painted
Cabin Ceiling : Epoxy Powder Painted + Led Light
Cabin Floor : Diamont Pattern Galvanized / ESB Sheet Metal
Cabin Mirror : None



CROME



PROFESSIONAL ELEVATOR SOLUTIONS

DETAILS

Cabin Coating	: Satinated Stainless Steel
Cabin Accessories	: Satinated Stainless Steel
Cabin Ceiling	: Led Light
Cabin Floor	: Diamont Pattern Stainless Steel
Cabin Mirror	: None

DETAYLAR

Kabin İçi Kaplama	: Satine Paslanmaz
Kabin İçi Aksesuar	: Satine Paslanmaz
Kabin İçi Tavan	: Led Aydınlatma
Kabin İçi Taban	: Gözyaşı Desenli Paslanmaz Sac
Kabin İçi Ayna Şekli	: Yok

SERVİS ASANSÖRÜ KABİNİ
DUMBWAITER ELEVATOR CAR

G800



Genişlik/Width Min 400 Max 1000 mm.

h: Min 600 max 1300 mm



SERVİS ASANSÖRÜ KAT KAPISI PASLANMAZ
DUMBWAITER ELEVATOR FLOOR DOORS CROM

TKC 60



PROFESSIONAL ELEVATOR SOLUTIONS

DETAYLAR

- Kabin İçi Kaplama : Satine Paslanmaz Duvarlar
Kabin İçi Aksesuar : Satine Paslanmaz
Kabin İçi Tavan : Satine Paslanmaz + Led Aydınlatma
Kabin İçi Taban : Baklava Desenli Galvanize Sac

DETAILS

- Cabin Coating : Epoxy Powder Painted Wall
Cabin Accessories : Epoxy Powder Painted
Cabin Ceiling : Epoxy Powder Painted + Led Light
Cabin Floor : Diamont Pattern Galvanized / ESB Sheet Metal

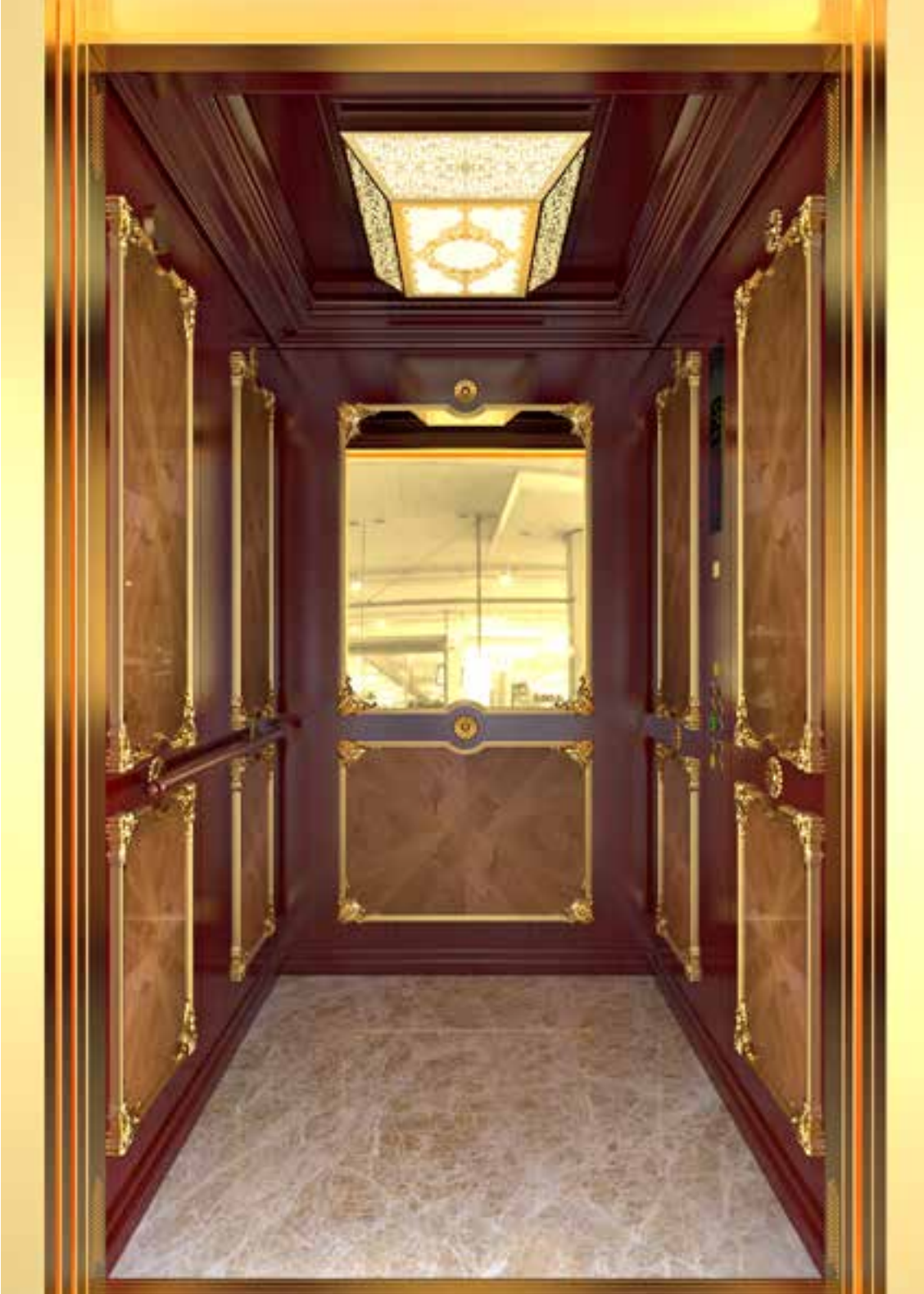
**DETAYLAR**

Kabin İçi Kaplama	: Doğal Ahşap Kaplama
Kabin İçi Aksesuar	: Doğal Ahşap
Kabin İçi Tavan	: Ahşap Tavan+ Özel
Kabin İçi Taban	: Armetür Granit
Kabin İçi Ayna Şekli	: Tam Boy

DETAILS

Cabin Coating	: Naturel Wood
Cabin Accessories	: Naturel Wood
Cabin Ceiling	: Naturel Wood + Special
Cabin Floor	: Light Granite
Cabin Mirror	: Full Height

**DETAYLAR**

- Kabin İçi Kaplama : Laminant + Router İşleme
 Kabin İçi Aksesuar : Paslanmaz
 Kabin İçi Tavan : Laminant + Router İşleme + Spot
 Kabin İçi Taban : Aydınlatma Granit
 Kabin İçi Ayna Şekli : Tam Boy + Arka Led Aydınlatma

DETAILS

- Cabin Coating : Laminate + Router
 Cabin Accessories : Stainless Steel
 Cabin Ceiling : Laminate + Router + Spot
 Cabin Floor : Light Granite
 Cabin Mirror : Full Height + Behind Led Light

L203



WODEL

WOOD

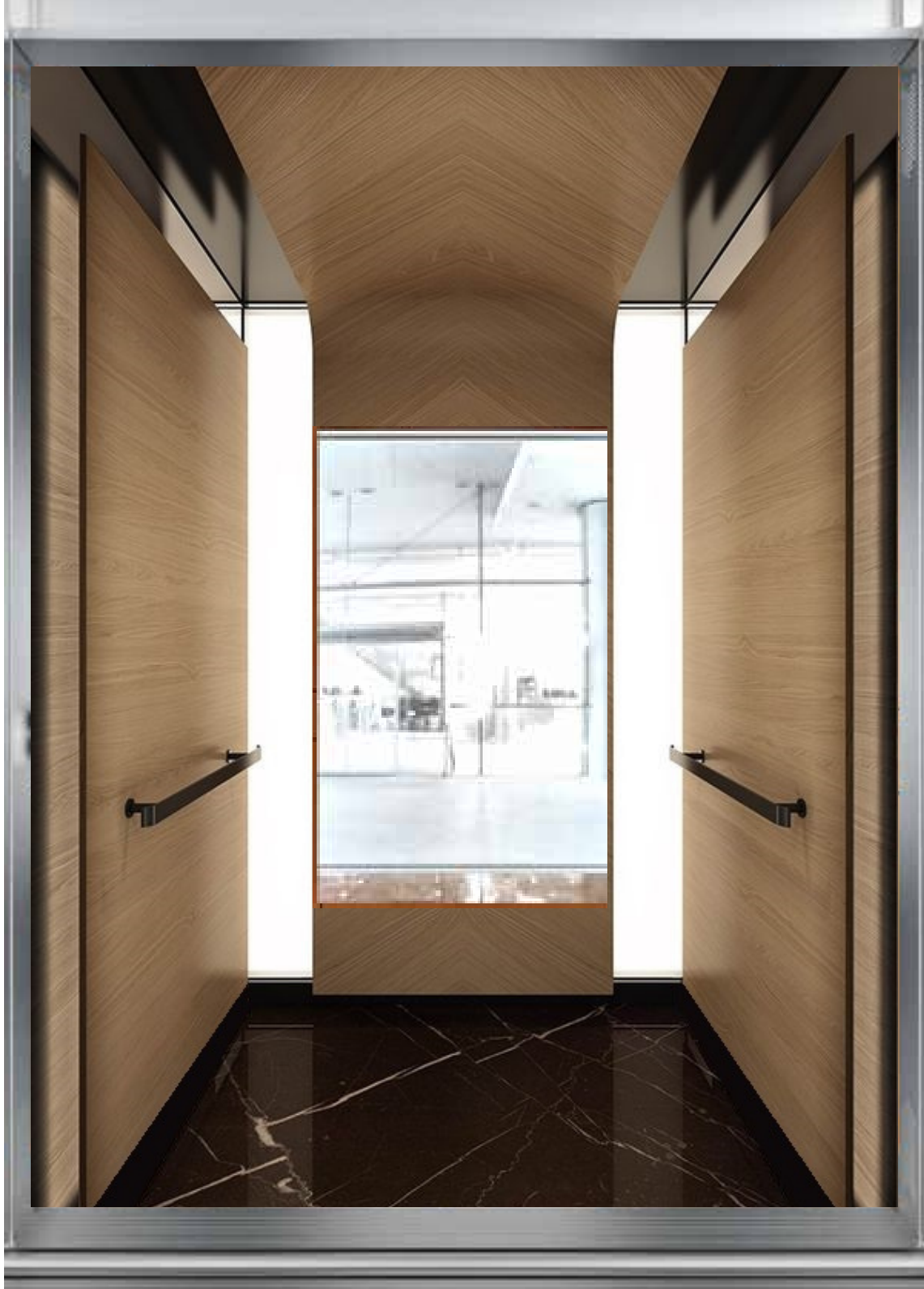

DETAYLAR

- Kabin İçi Kaplama : Laminant + Router İşleme
Kabin İçi Aksesuar : Paslanmaz
Kabin İçi Tavan : Laminant + Router İşleme + Gizli Aydınlatma
Kabin İçi Taban : Granit
Kabin İçi Ayna Şekli : Tam Boy + Arka Led Aydınlatma

DETAILS

- Cabin Coating : Laminate + Router
Cabin Accessories : Stainless Steel
Cabin Ceiling : Laminate + Router + Spot
Cabin Floor : Light Granite
Cabin Mirror : Full Height + Behind Led Light

PROFESSIONAL ELEVATOR SOLUTIONS

**DETAYLAR**

Kabin İçi Kaplama	: Laminant + Router
Kabin İçi Aksesuar	: İşleme Ayna Paslanmaz
Kabin İçi Tavan	: Lazer Kesim
Kabin İçi Taban	: Granit
Kabin İçi Ayna Şekli	: Özel Tasarım

DETAILS

Cabin Coating	:Laminate + Router
Cabin Accessories	:Mirror Stainless Steel
Cabin Ceiling	:Laser Cutting
Cabin Floor	:Granite
Cabin Mirror	:Special Design

**DETAILS**

Cabin Coating	:Laminate
Cabin Accessories	:Mirror Stainless Steel
Cabin Ceiling	:Laser Cut + Special Design
Cabin Floor	:Granite
Cabin Mirror	:Full Height

DETAYLAR

Kabin İçi Kaplama	: Laminant
Kabin İçi Aksesuar	: Ayna Paslanmaz
Kabin İçi Tavan	: Lazer Kesim + Özel
Kabin İçi Taban	: Tasarım Granit
Kabin İçi Ayna Şekli	: Tam Boy

**DETAYLAR**

Kabin İçi Kaplama	: Postforming Laminat
Kabin İçi Aksesuar	: Satine Paslanmaz
Kabin İçi Tavan	: Lazer Kesim
Kabin İçi Taban	: Granit
Kabin İçi Ayna Şekli	: Yarım Boy

DETAILS

Cabin Coating	: Postforming Laminate
Cabin Accessories	: Satinated Stainless Steel
Cabin Ceiling	: Laser Cut
Cabin Floor	: Granite
Cabin Mirror	: Half Height

**DETAILS**

Cabin Coating	: Laminat
Cabin Accessories	: Satinated Stainless Steel
Cabin Ceiling	: Laser Cut
Cabin Floor	: PVC - Anti Bacterial
Cabin Mirror	: Full Height

DETAYLAR

Kabin İçi Kaplama	: Laminant
Kabin İçi Aksesuar	: Satine Paslanmaz
Kabin İçi Tavan	: Lazer Kesim
Kabin İçi Taban	: PVC - Antibakteriyel
Kabin İçi Ayna Şekli	: Tam Boy

**DETAYLAR**

- Kabin İçi Kaplama : Laminant
Kabin İçi Aksesuar : Ayna Paslanmaz
Kabin İçi Tavan : Lazer Kesim
Kabin İçi Taban : PVC - Antibakteriyel
Kabin İçi Ayna Şekli : Tam Boy

DETAILS

- Cabin Coating :Laminate
Cabin Accessories :Mirror Stainless Steel
Cabin Ceiling :Laser Cut
Cabin Floor :PVC - Anti Bacterial
Cabin Mirror :Full Height

**DETAILS**

Cabin Coating	: Laminate
Cabin Accessories	: Satinated Stainless Steel
Cabin Ceiling	: Laser Cut
Cabin Floor	: PVC - Anti Bacterial
Cabin Mirror	: Full Height

DETAYLAR

Kabin İçi Kaplama	: Laminant
Kabin İçi Aksesuar	: Satine Paslanmaz
Kabin İçi Tavan	: Lazer Kesim
Kabin İçi Taban	: PVC - Antibakteriyel
Kabin İçi Ayna Şekli	: Tam Boy

**DETAYLAR**

- Kabin İçi Kaplama : Postforming Laminat
Kabin İçi Aksesuar : Ayna Paslanmaz
Kabin İçi Tavan : Lazer Kesim
Kabin İçi Taban : Granit
Kabin İçi Ayna Şekli : Yarım Boy

DETAILS

- Cabin Coating :Postforming Laminat
Cabin Accessories :Mirror Stainless Steel
Cabin Ceiling :Laser Cut
Cabin Floor :Granite
Cabin Mirror :Half Height

**DETAYLAR**

- Kabin İçi Kaplama : Laminant
 Kabin İçi Aksesuar : Satine Paslanmaz
 Kabin İçi Tavan : Özel Tasarım + Spot Aydınlatma
 Kabin İçi Taban : Granit
 Kabin İçi Ayna Şekli : Tam Boy

DETAILS

- Cabin Coating : Laminate
 Cabin Accessories : Satinated Stainless Steel
 Cabin Ceiling : Special Design + Spot Light
 Cabin Floor : Granite
 Cabin Mirror : Full Height

G350



BABİL

WOOD



DETAYLAR

- Kabin İçi Kaplama : Laminant
Kabin İçi Aksesuar : Satine Paslanmaz
Kabin İçi Tavan : Özel Tasarım + Spot Aydınlatma
Kabin İçi Taban : Granit
Kabin İçi Ayna Şekli : Tam Boy

DETAILS

- Cabin Coating : Laminant
Cabin Accessories : Satinated Stainless Steel
Cabin Ceiling : Special Design + Spot Light
Cabin Floor : Granite
Cabin Mirror : Full Height

PROFESSIONAL ELEVATOR SOLUTIONS

**DETAYLAR**

Kabin İçi Kaplama	: Laminant
Kabin İçi Aksesuar	: Satine Paslanmaz
Kabin İçi Tavan	: Lazer Kesim + Spot
Kabin İçi Taban	: Aydınlatma Granit
Kabin İçi Ayna Şekli	: Tam Boy

DETAILS

Cabin Coating	: Laminate
Cabin Accessories	: Satinated Stainless Steel
Cabin Ceiling	: Laser Cut + Spot Light
Cabin Floor	: Granite
Cabin Mirror	: Full Height

G310



ELEMENT

WOOD



DETAYLAR

- Kabin İçi Kaplama : Laminant
Kabin İçi Aksesuar : Satine Paslanmaz
Kabin İçi Tavan : Lazer Kesim + Spot
Kabin İçi Taban : Aydınlatma Granit
Kabin İçi Ayna Şekli : Tam Boy

DETAILS

- Cabin Coating : Laminate
Cabin Accessories : Satinated Stainless Steel
Cabin Ceiling : Laser Cut + Spot Light
Cabin Floor : Granite
Cabin Mirror : Full Height

PROFESSIONAL ELEVATOR SOLUTIONS

**DETAYLAR**

- Kabin İçi Kaplama : Laminant
Kabin İçi Aksesuar : Satine Paslanmaz
Kabin İçi Tavan : Lazer Kesim
Kabin İçi Taban : PVC - Antibakteriyel
Kabin İçi Ayna Şekli : Tam Boy

DETAILS

- Cabin Coating : Laminate
Cabin Accessories : Satinated Stainless Steel
Cabin Ceiling : Laser Cut
Cabin Floor : PVC - Anti Bacterial
Cabin Mirror : Full Height

**DETAYLAR**

Kabin İçi Kaplama	: Laminant
Kabin İçi Aksesuar	: Paslanmaz
Kabin İçi Tavan	: Lazer Kesim
Kabin İçi Taban	: PVC - Antibakteriyel
Kabin İçi Ayna Şekli	: Tam Boy

DETAILS

Cabin Coating	: Laminate
Cabin Accessories	: Stainless Steel
Cabin Ceiling	: Laser Cut
Cabin Floor	: PVC - Anti Bacterial
Cabin Mirror	: Full Height

G325



LİMAS

WOOD



DETAYLAR

- Kabin İçi Kaplama : Laminant
Kabin İçi Aksesuar : Paslanmaz
Kabin İçi Tavan : Lazer Kesim
Kabin İçi Taban : PVC - Antibakteriyel
Kabin İçi Ayna Şekli : Tam Boy

DETAILS

- Cabin Coating : Laminate
Cabin Accessories : Stainless Steel
Cabin Ceiling : Laser Cut
Cabin Floor : PVC - Anti Bacterial
Cabin Mirror : Full Height

PROFESSIONAL ELEVATOR SOLUTIONS

**DETAYLAR**

Kabin İçi Kaplama	: Laminant
Kabin İçi Aksesuar	: Ayna Satine Paslanmaz
Kabin İçi Tavan	: Lazer Kesim
Kabin İçi Taban	: Granit
Kabin İçi Ayna Şekli	: Tam Boy

DETAILS

Cabin Coating	:Laminate
Cabin Accessories	:Mirror Stainless Steel
Cabin Ceiling	:Laser Cut
Cabin Floor	:Granite
Cabin Mirror	:Full Height

**DETAYLAR**

- Kabin İçi Kaplama : Lamine Cam
Kabin İçi Aksesuar : Satine Paslanmaz
Kabin İçi Tavan : Özel Tasarım
Kabin İçi Taban : Granit
Kabin İçi Ayna Şekli : Tam Boy

DETAILS

- Cabin Coating : Laminated Glass
Cabin Accessories : Satinated Stainless Steel
Cabin Ceiling : Special Design
Cabin Floor : Granite
Cabin Mirror : Full Height

**DETAYLAR**

Kabin İçi Kaplama	: Lamine Cam
Kabin İçi Aksesuar	: Ayna Paslanmaz
Kabin İçi Tavan	: Lazer Kesim
Kabin İçi Taban	: Granit
Kabin İçi Ayna Şekli	: Yarım Boy

DETAILS

Cabin Coating	:Laminated Glass
Cabin Accessories	:Mirror Stainless Steel
Cabin Ceiling	:Laser Cut
Cabin Floor	:Granite
Cabin Mirror	:Half Height

**DETAYLAR**

- Kabin İçi Kaplama : Lamine Cam
Kabin İçi Aksesuar : Satine Paslanmaz
Kabin İçi Tavan : Özel Tasarım
Kabin İçi Taban : Granit
Kabin İçi Ayna Şekli : Tam Boy

DETAILS

- Cabin Coating : Laminated Glass
Cabin Accessories : Satinated Stainless Steel
Cabin Ceiling : Special Design
Cabin Floor : Granite
Cabin Mirror : Full Height

**DETAYLAR**

Kabin İçi Kaplama	: Lamine Cam
Kabin İçi Aksesuar	: Ayna Paslanmaz
Kabin İçi Tavan	: Lazer Kesim
Kabin İçi Taban	: Granit
Kabin İçi Ayna Şekli	: Yarım Boy

DETAILS

Cabin Coating	:Laminated Glass
Cabin Accessories	:Mirror Stainless Steel
Cabin Ceiling	:Laser Cut
Cabin Floor	:Granite
Cabin Mirror	:Half Height

**DETAYLAR**

Kabin İçi Kaplama	: Lamine Cam
Kabin İçi Aksesuar	: Ayna Paslanmaz
Kabin İçi Tavan	: Lazer Kesim
Kabin İçi Taban	: Granit
Kabin İçi Ayna Şekli	: Yarım Boy

DETAILS

Cabin Coating	:Laminated Glass
Cabin Accessories	:Mirror Stainless Steel
Cabin Ceiling	:Laser Cut
Cabin Floor	:Granite
Cabin Mirror	:Half Height

**DETAYLAR**

- Kabin İçi Kaplama : Lamine Cam
 Kabin İçi Aksesuar : Satine Paslanmaz
 Kabin İçi Tavan : Lazer Kesim + Spot
 Kabin İçi Taban : Aydınlatma Granit
 Kabin İçi Ayna Şekli : Tam Boy

DETAILS

- Cabin Coating : Laminated Glass
 Cabin Accessories : Satinated Stainless Steel
 Cabin Ceiling : Laser Cut + Spot Light
 Cabin Floor : Granite
 Cabin Mirror : Full Height

**DETAYLAR**

Kabin İçi Kaplama	: Lamine Cam
Kabin İçi Aksesuar	: Satine Paslanmaz
Kabin İçi Tavan	: Lazer Kesim
Kabin İçi Taban	: Granit
Kabin İçi Ayna Şekli	: Tam Boy

DETAILS

Cabin Coating	: Laminated Glass
Cabin Accessories	: Satinated Stainless Steel
Cabin Ceiling	: Laser Cut
Cabin Floor	: Granite
Cabin Mirror	: Full Height

**DETAYLAR**

- Kabin İçi Kaplama : Lamine Cam
Kabin İçi Aksesuar : Satine Paslanmaz
Kabin İçi Tavan : Lazer Kesim
Kabin İçi Taban : Granit
Kabin İçi Ayna Şekli : Tam Boy

DETAILS

- Cabin Coating : Laminated Glass
Cabin Accessories : Satinated Stainless Steel
Cabin Ceiling : Laser Cut
Cabin Floor : Granite
Cabin Mirror : Full Height

G410



ROL MODEL

GLASS



PROFESSIONAL ELEVATOR SOLUTIONS

DETAYLAR

- Kabin İçi Kaplama : Özel Resim Uygulamalı Polikarbon
Kabin İçi Aksesuar : Satine Paslanmaz
Kabin İçi Tavan : Satine Paslanmaz Lazer Kesim
Kabin İçi Taban : Granit
Kabin İçi Ayna Şekli : Tam Boy

DETAILS

- Cabin Coating : Special Painting Applied Polycarbonate
Cabin Accessories : Satinated Stainless Steel
Cabin Ceiling : Satinated Stainless Steel Laser Cut
Cabin Floor : Granite
Cabin Mirror : Full Height

G461



DELTA

GLASS



DETAYLAR

- Kabin İçi Kaplama : Polikarbon Cam
Kabin İçi Aksesuar : Satine Paslanmaz
Kabin İçi Tavan : Lazer Kesim
Kabin İçi Taban : Granit
Kabin İçi Ayna Şekli : Tam Boy

DETAILS

- Cabin Coating : L Polycarbonate glass
Cabin Accessories : Satinated Stainless Steel
Cabin Ceiling : Laser Cut
Cabin Floor : Granite
Cabin Mirror : Full Height

PROFESSIONAL ELEVATOR SOLUTIONS

501



PANORAMA



PROFESSIONAL ELEVATOR SOLUTIONS

DETAYLAR

Kabin İçi Kaplama	: Satine Paslanmaz
Kabin İçi Aksesuar	: Ayna Paslanmaz
Kabin İçi Tavan	: Lazer Kesim
Kabin İçi Taban	: Granit
Kabin İçi Ayna Şekli	: Yok

DETAILS

Cabin Coating	:Satinated Stainless Steel
Cabin Accessories	:Mirror Stainless Steel
Cabin Ceiling	:Laser Cut
Cabin Floor	:Granite
Cabin Mirror	:None



503



PANORAMA



PROFESSIONAL ELEVATOR SOLUTIONS

DETAYLAR

Kabin İçi Kaplama	: Satine Paslanmaz
Kabin İçi Aksesuar	: Satine Paslanmaz
Kabin İçi Tavan	: Lazer Kesim
Kabin İçi Taban	: Granit
Kabin İçi Ayna Şekli	: Yok

DETAILS

Cabin Coating	: Satinated Stainless Steel
Cabin Accessories	: Satinated Stainless Steel
Cabin Ceiling	: Laser Cut
Cabin Floor	: Granite
Cabin Mirror	: None





DETAYLAR

Kabin İçi Kaplama	: Satine Paslanmaz
Kabin İçi Aksesuar	: Ayna Paslanmaz
Kabin İçi Tavan	: Lazer Kesim
Kabin İçi Taban	: Granit
Kabin İçi Ayna Şekli	: Yok

DETAILS

Cabin Coating	:Satinated Stainless Steel
Cabin Accessories	:Mirror Stainless Steel
Cabin Ceiling	:Laser Cut
Cabin Floor	:Granite
Cabin Mirror	:None





DETAYLAR

Kabin İçi Kaplama	: Satine Paslanmaz
Kabin İçi Aksesuar	: Ayna Paslanmaz
Kabin İçi Tavan	: Lazer Kesim
Kabin İçi Taban	: Granit
Kabin İçi Ayna Şekli	: Yok

DETAILS

Cabin Coating	:Satinated Stainless Steel
Cabin Accessories	:Mirror Stainless Steel
Cabin Ceiling	:Laser Cut
Cabin Floor	:Granite
Cabin Mirror	:None





DETAYLAR

Kabin İçi Kaplama	: Lamine Cam Duvarlar
Kabin İçi Aksesuar	: Satine Paslanmaz
Kabin İçi Tavan	: Lazer Kesim
Kabin İçi Taban	: Granit
Kabin İçi Ayna Şekli	: Yok

DETAILS

Cabin Coating	: Laminated Glass Wall
Cabin Accessories	: Satinated Stainless Steel
Cabin Ceiling	: Laser Cut
Cabin Floor	: Granite
Cabin Mirror	: None



**DETAYLAR**

Kabin İçi Kaplama	: Satine Paslanmaz
Kabin İçi Aksesuar	: Satine Paslanmaz
Kabin İçi Tavan	: Lazer Kesim
Kabin İçi Taban	: Granit
Kabin İçi Ayna Şekli	: Yok

DETAILS

Cabin Coating	: Satinated Stainless Steel
Cabin Accessories	: Satinated Stainless Steel
Cabin Ceiling	: Laser Cut
Cabin Floor	: Granite
Cabin Mirror	: None



**DETAYLAR**

- Kabin İçi Kaplama : ESB Boyalı Duvarlar
 Kabin İçi Aksesuar : ESB Boyalı
 Kabin İçi Tavan : ESB Boyalı + Özel Dizayn + Led Aydınlat.
 Kabin İçi Taban : Granit
 Kabin İçi Ayna Şekli : Tam Boy

DETAILS

- Cabin Coating :Epoxy Powder Painted Wall
 Cabin Accessories :Epoxy Powder Painted
 Cabin Ceiling :Epoxy Powder Painted + Special Design + Led
 Cabin Floor Light :Granite
 Cabin Mirror :Full Height



DETAYLAR

Kabin İçi Kaplama	: ESB Boyalı Duvarlar
Kabin İçi Aksesuar	: ESB Boyalı
Kabin İçi Tavan	: ESB Boyalı + Özel Dizayn + Spot Aydınl..
Kabin İçi Taban	: Granit
Kabin İçi Ayna Şekli	: Tam Boy

DETAILS

Cabin Coating	: Epoxy Powder Painted Wall
Cabin Accessories	: Epoxy Powder Painted
Cabin Ceiling	: Epoxy Powder Painted + Special Design + Spot Light
Cabin Floor	: Granite
Cabin Mirror	: Full Height

**DETAYLAR**

- Kabin İçi Kaplama :ESB Boyalı Duvarlar
 Kabin İçi Aksesuar :Farklı Renkli ESB Boyalı
 Kabin İçi Tavan :ESB Boyalı + Özel Dizayn + Spot
 Kabin İçi Taban Aydınlatma :Granit
 Kabin İçi Ayna Şekli :Yarım Boy

DETAILS

- Cabin Coating : Epoxy Powder Painted Wall
 Cabin Accessories : Different Color Epoxy Powder Painted
 Cabin Ceiling : Epoxy Powder Painted + Special Design + Spot Light
 Cabin Floor : Granite
 Cabin Mirror : Half Height



RALL



PROFESSIONAL ELEVATOR SOLUTIONS

DETAYLAR

- Kabin İçi Kaplama : ESB Boyalı Duvarlar
Kabin İçi Aksesuar : ESB Boyalı
Kabin İçi Tavan : ESB Boyalı + Led
Kabin İçi Taban : Aydınlatma Alüminyum Çeta
Kabin İçi Ayna Şekli : Tam Boy Ayna Paslanmaz

DETAILS

- Cabin Coating : Epoxy Powder Painted Wall
Cabin Accessories : Epoxy Powder Painted
Cabin Ceiling : Epoxy Powder Painted + Led Light
Cabin Floor : Aluminum Checker Plate
Cabin Mirror : Full Height Mirror Stainless Steel

İTFAİYECİ KABİNİ

FIRE FIGHTERS LIFT CAR

110



EN 81 - 72

RALL



PROFESSIONAL ELEVATOR SOLUTIONS

DETAYLAR

Kabin İçi Kaplama	: ESB Boyalı Duvarlar
Kabin İçi Aksesuar	: ESB Boyalı Duvarlar
Kabin İçi Tavan	: IP-54 Led Aydınlatma
Kabin İçi Taban	: Alüminyum Çeta Desen
Kabin İçi Ayna Şekli	: Yok

DETAILS

Cabin Coating	: Epoxy Powder Painted Wall
Cabin Accessories	: Epoxy Powder Painted
Cabin Ceiling	: IP-54 Led Light
Cabin Floor	: Aluminum Checkered Pattern
Cabin Mirror	: None



RALL



PROFESSIONAL ELEVATOR SOLUTIONS

DETAYLAR

- Kabin İçi Kaplama : ESB Boyalı Duvarlar
Kabin İçi Aksesuar : ESB Boyalı
Kabin İçi Tavan : ESB Boyalı + Led Aydınlatma
Kabin İçi Taban : Baklava Desenli Galvanize / Boyalı Sac
Kabin İçi Ayna Şekli : Yok

DETAILS

- Cabin Coating : Epoxy Powder Painted Wall
Cabin Accessories : Epoxy Powder Painted
Cabin Ceiling : Epoxy Powder Painted + Led Light
Cabin Floor : Diamont Pattern Galvanized / ESB Sheet Metal
Cabin Mirror : None



RALL



PROFESSIONAL ELEVATOR SOLUTIONS

DETAYLAR

Kabin İçi Kaplama	: ESB Boyalı Duvarlar
Kabin İçi Aksesuar	: ESB Boyalı
Kabin İçi Tavan	: ESB Boyalı + Led Aydınlatma
Kabin İçi Taban	: Baklava Desenli Galvanize / Boyalı Sac
Kabin İçi Ayna Şekli	: Yok

DETAILS

Cabin Coating	: Epoxy Powder Painted Wall
Cabin Accessories	: Epoxy Powder Painted
Cabin Ceiling	: Epoxy Powder Painted + Led Light
Cabin Floor	: Diamont Pattern Galvanized / ESB Sheet Metal
Cabin Mirror	: None

SERVİS ASANSÖRÜ KABİNİ
DUMBWAITER ELEVATOR CAR

G800



Genişlik/Width Min 400 Max 1000 mm.

RALL

h: Min 600 max 1300 mm



SERVİS ASANSÖRÜ KAT KAPISI ELEKTROSTATİK BOYA
DUMBWAITER ELEVATOR FLOOR DOORS ELECTROSTATIC PAINT

TKB 60



TKB 50



DETAYLAR

- Kabin İçi Kaplama : ESB Boyalı Duvarlar
- Kabin İçi Aksesuar : ESB Boyalı
- Kabin İçi Tavan : ESB Boyalı
- Kabin İçi Taban : ESB Boyalı Sac

DETAILS

- Cabin Coating : Epoxy Powder Painted Wall
- Cabin Accessories : Epoxy Powder Painted
- Cabin Ceiling : Epoxy Powder Painted
- Cabin Floor : ESB Painted

PROFESSIONAL ELEVATOR SOLUTIONS

KABİN KARKASLARI

CAR FRAME



MCK 811

MCK 822

MCK823

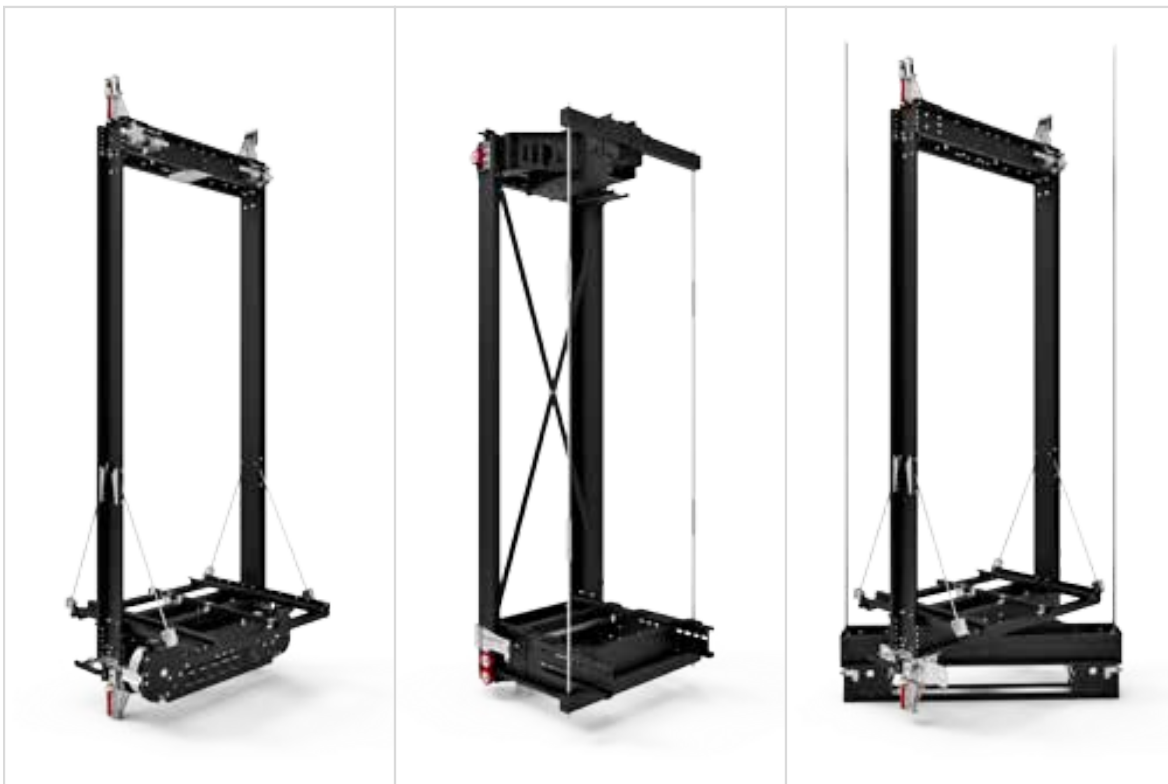

MCK 826

MCK 829

MCK 825

PROFESSIONAL ELEVATOR SOLUTIONS

HİDROLİK L TİPİ KARKAS

HYDRAULIC L TYPE CAR FRAME



MCK 881



PROFESSIONAL ELEVATOR SOLUTIONS

HİDROLİK TANDEM TİP KARKAS

HYDRAULIC TANDEM TYPE CAR FRAME



MCK 882



PROFESSIONAL ELEVATOR SOLUTIONS

KARŞI AĞIRLIK KARKASI 1/1 - 1/2 TEK SIRA
WEIGHT FRAME 1/1 - 1/2 SINGLE ROW



PROFESSIONAL ELEVATOR SOLUTIONS

KARŞI AĞIRLIK KARKASI 1/2 ÇİFT SIRA
WEIGHT FRAME 1/2 DOUBLE ROW



AK 824



PROFESSIONAL ELEVATOR SOLUTIONS

KAYMA FREN SEÇENEKLERİ

PROGRESSIVE SAFETY GEARS



CL-SG CİFT YON

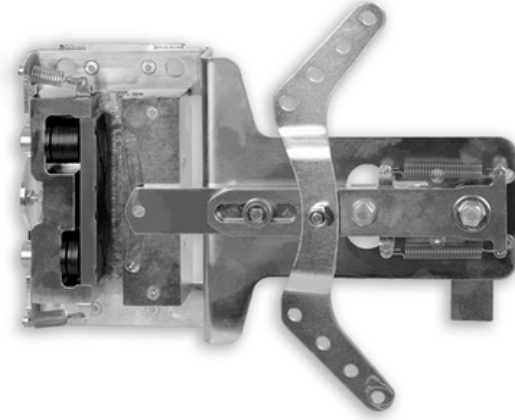

CL-SG TEK YON

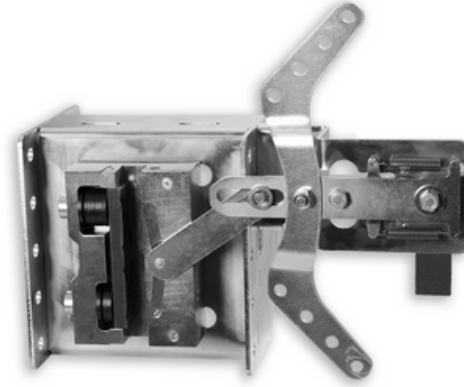

DIN EN81-20/50

PC24GA / PC24GO / PC24GU

Q & P max. **5498 kg** va max. 3,5 m/s

NEU mit Doppelgleitbacke
NEW with easy release mechanism



DIN EN81-20/50

PC100E / PC100U

Q & P max. **13000 kg** va max. 2,63 m/s

Q & P max. **6957 kg** va max. 3,5 m/s

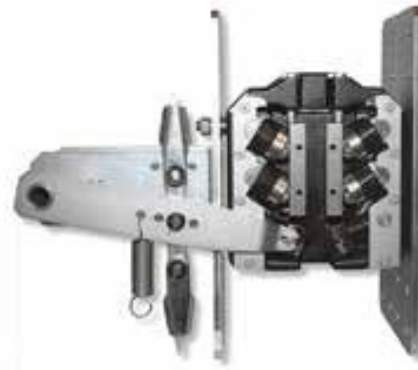

DIN EN81-20/50

PC100ES

Q & P max. **3000 kg** va max. **5,06 m/s**

NEU erhöhte Auslösegeschwindigkeit
NEW for higher speed



DIN EN81-20/50

PC200E / PC200U

Q & P max. **18968 kg** va max. 2,0 m/s



PROFESSIONAL ELEVATOR SOLUTIONS

TAVAN SEÇENEKLERİ

CEILING OPTIONS



MT-0100



MT-0200



MT-0300



MT-0400



MT-0500



MT-0600



MT-0700



MT-0800



MT-0900



MT-1000



MT-1100



MT-1200



MT-1300



MT-1400



MT-1500

PROFESSIONAL ELEVATOR SOLUTIONS

TAVAN SEÇENEKLERİ

CEILING OPTIONS



MT-1600



MT-1700



MT-1800



MT-1900



MT-2000



MT-2100



MT-2200



MT-2300



MT-2400



MT-2500



MT-2600



MT-2700



MT-2800



MT-2900



MT-3000

PROFESSIONAL ELEVATOR SOLUTIONS

ZEMİN SEÇENEKLERİ

FLOOR OPTIONS



GRANİT ZEMİN SEÇENEKLERİ /

GRANITE FLOOR OPTIONS



ROSA BETA



ROSA PORINO



BALMORAL RED



BLUE PEARL



BUTTERFLY GREEN



NERO ZIMBABWE



EMPRADOR DARK

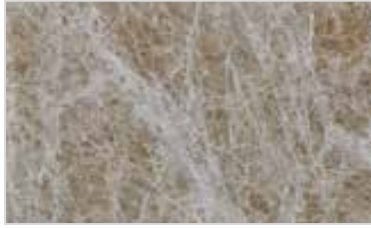

EMPRADOR LIGHT



STAR GALAXY

PVC ZEMİN SEÇENEKLERİ /

PVC FLOOR OPTIONS



PVC

F001



PVC

F002



PVC

F003

METAL ZEMİN SEÇENEKLERİ /

METAL FLOOR OPTIONS



ALUMINUM SHEET

F004



STAINLESS STEEL SHEET

F005



STEEL SHEET

F006

PROFESSIONAL ELEVATOR SOLUTIONS

PASLANMAZ SEÇENEKLERİ

STAINLESS OPTIONS



MIRROR



STAIN

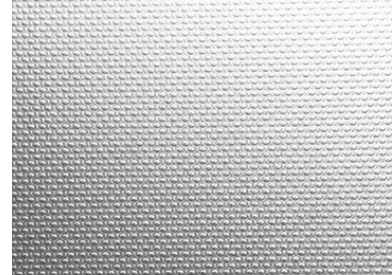

DT-PT



H-DG



H-GD



H-CP



M-DG

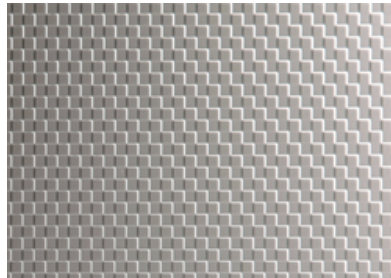

SQ-PN



YH-E01



YH-E07

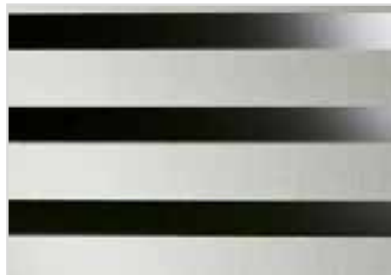

YH-E51

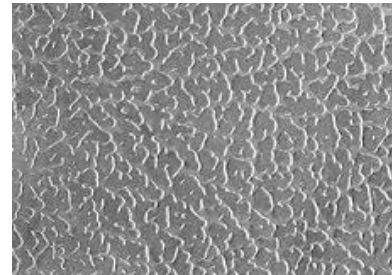

LR-PN



ZK-007



ZK-015

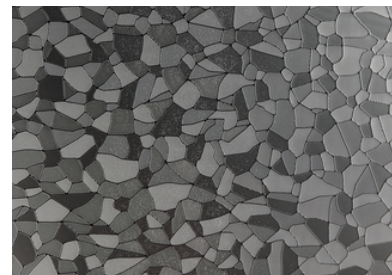

MOS-PT

PROFESSIONAL ELEVATOR SOLUTIONS

LAMİNAT SEÇENEKLERİ

LAMINATE OPTIONS

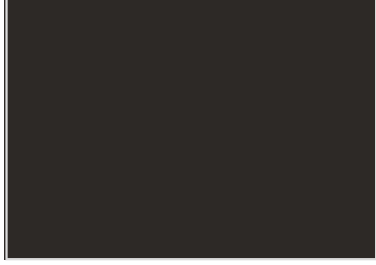

1049



2016



3013



3017



3023



3038



3051



3053



3077



3094



3096



3123



3126



3151



5142

PROFESSIONAL ELEVATOR SOLUTIONS

RAL-RENK SEÇENEKLERİ

RAL-COLOR OPTIONS



RAL 1001



RAL 1013



RAL 1018



RAL 2008



RAL 3020



RAL 4003



RAL 5010



RAL 5018



RAL 7016



RAL 7032



RAL 7039



RAL 8025



RAL 9005



RAL 9006



RAL 9016

PROFESSIONAL ELEVATOR SOLUTIONS

KÜPEŞTE SEÇENEKLERİ

HANDRAIL OPTIONS



HRL-01



HRL-02



HRL-03



HRL-04



HRL-05



HRL-06

PROFESSIONAL ELEVATOR SOLUTIONS

ÇARPMA BANT SEÇENEKLERİ

BUMPER RAIL OPTIONS



BR-01



BR-02



BR-03



BR-04



BR-05



BR-06



HSBR-01



HSBR-01



CBR-01



CBR-02

PROFESSIONAL ELEVATOR SOLUTIONS

KOMPLE ASANSÖR SİSTEMLERİ

COMPLETE ELEVATOR SYSTEMS



MR ELEVATOR - MAKİNE DAİRELİ

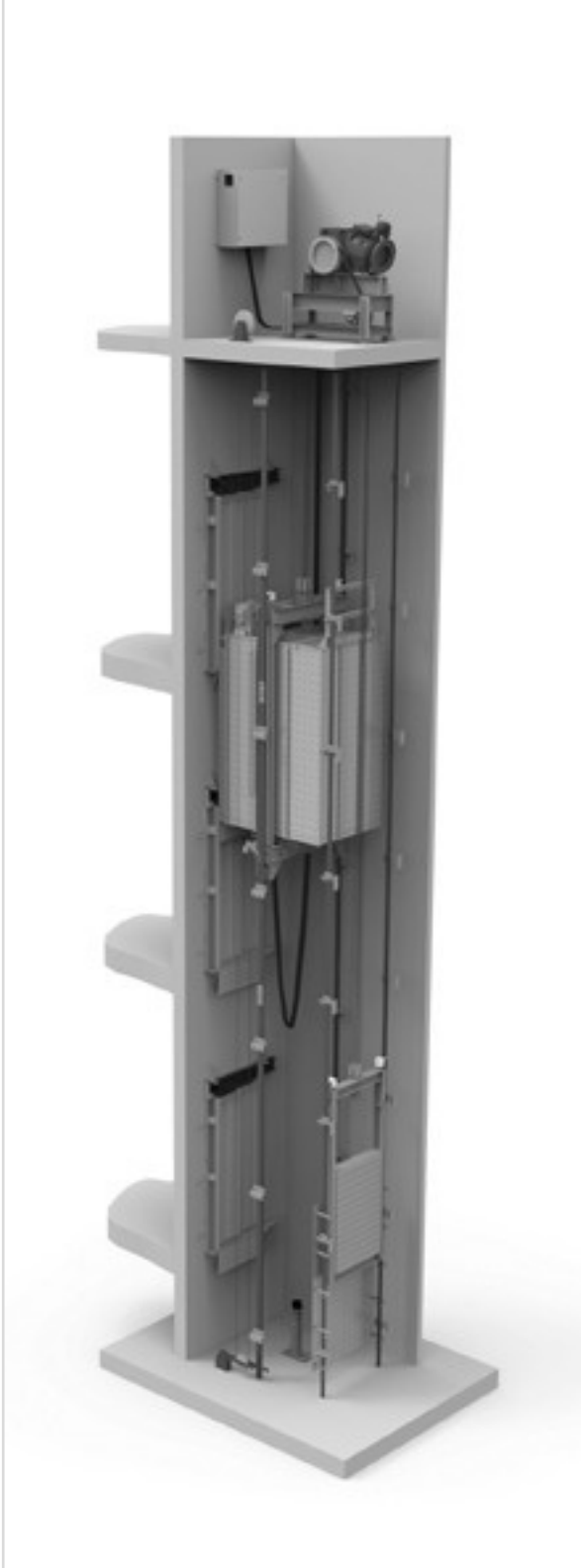

MRL ELEVATOR - MAKİNE DAİRESİZ

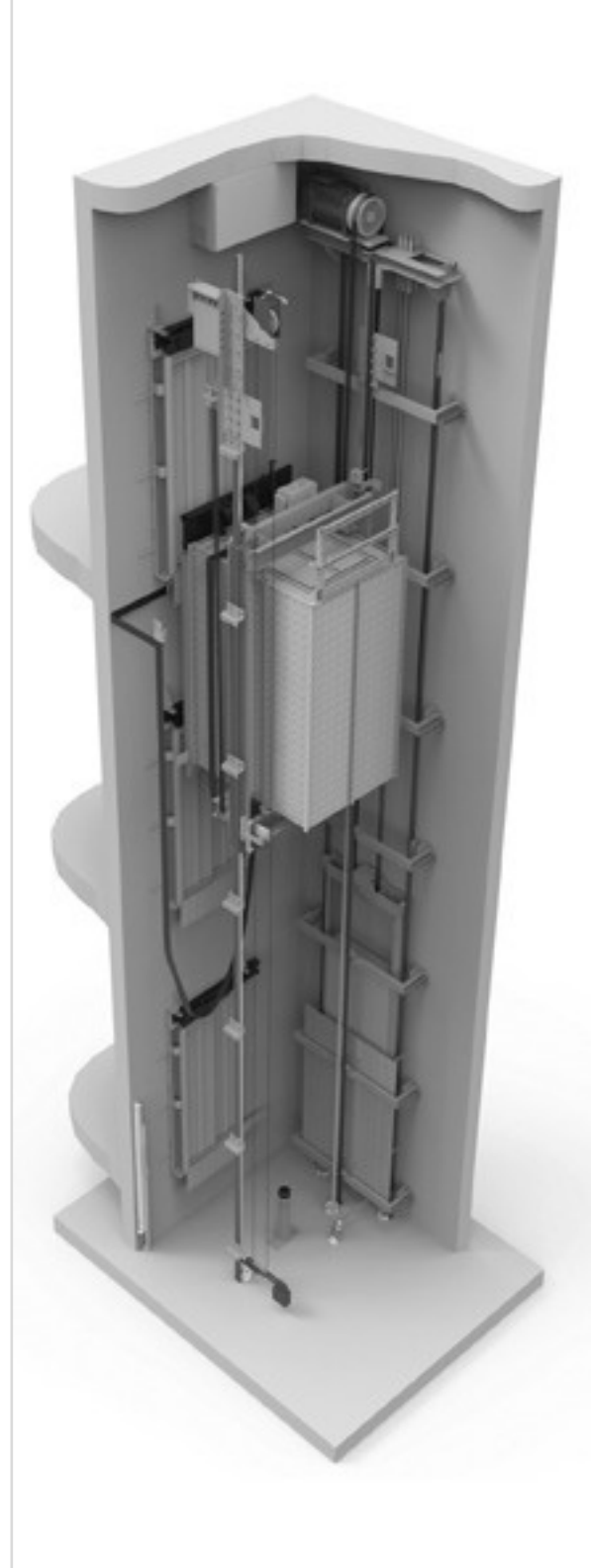

PROFESSIONAL ELEVATOR SOLUTIONS

MR Sistem (Makine Daireli Sistem)

Makina daireli asansörlerimizin, 30 kata kadar olan binalarda, 3000 kg. kapasiteye ve 2,50 m/sn hıza kadar, tesis edilebilme imkanı vardır. Makine daireli yüksek kapasiteli asansörler özellikle yolcu terminalleri, çok katlı mağazalar, alışveriş merkezleri ile eğitim, kültür ve sağlık kuruluşları için uygun bir çözüm oluşturmaktadır. VWF kontrolü son derece sessiz ve konforlu bir seyir sağlarken, düşük motor devirlerinde de sistemin güvenliğini en üst düzeye çıkartmaktadır.

MR Systems (Machine Room Systems)

Our machine room elevators can be installed in buildings up to 30 floors, up to 3000 kg. capacity and 2,50 m/sec speed. High capacity elevators with machine room are especially suitable for passenger terminals, multi-storey stores, shopping centres, educational, cultural and health institutions. VWF control provides an extremely quiet and comfortable ride and maximises the safety of the system at low engine speeds.



GEARBOX MACHINE



MRL Sistem (Makine Dairesiz Sistem)

Makina dairesiz asansörlerimizin, 30 kata kadar olan binalarda, 3000 kg. kapasiteye ve 2,50 m/sn hıza kadar, tesis edilebilme imkanı vardır. Makine dairesiz yüksek kapasiteli asansörler özellikle yolcu terminalleri, çok katlı mağazalar, alışveriş merkezleri ile eğitim, kültür ve sağlık kuruluşları için uygun bir çözüm oluşturmaktadır. Geleneksel motorlara göre %40'a varan enerji tasarrufunun yanısıra, dişli kutusunun olmaması nedeniyle yıpranma son derece az olmaktadır. Sistemin yağsız olması çevre kirliliği ve yangın tehlikesini tamamen ortadan kaldırmaktadır. VVVF kontrolü ise son derece sessiz ve konforlu bir seyir sağlarken, düşük motor devirlerinde de sistemin güvenliğini en üst düzeye çıkartmaktadır.

MRL Systems (Machine Roomless Systems)

Machine roomless systems elevators can be assemble the buildings that have max. 30 floors , 3000 kilograms , 2,50 meter/second. Machine roomless systems elevators are used in passsenger terminal facilities, hospitals, schools,malls. Compared with a conventional engine up to 40% energy savings in addition to the gearbox is extremely less due to the lack of wear the system works without oil, this situation eliminates anviromental pollution and the danger of fire. Control vvvf provides extremely quiet and comfortable journey. Also low engine speed puts security of the system up high point.



GEARLESS MACHINE

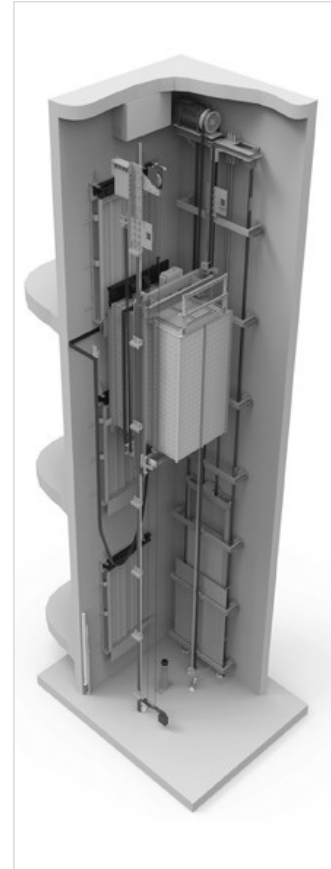

KOMPLE HİDROLİK ASANSÖR SİSTEMLERİ

COMPLETE HYDRAULIC LIFT SYSTEMS



Hidrolik asansörler, elektrikli motorunun tahrik ettiği hidrolik pompa ünitesinin yağı itmesi veya çekmesi ile pistonun hareketi ile kabinin tahrik kabiliyetini sağlayan sistemlerdir.

Genel olarak kullanılan tahrik sisteminde yukarı yönde hareket motor-pompa ile aşağı yöne hareketlerde ise asansör kabininin kendi ağırlığı kullanılır.

Tahrik sisteminde bir diğer alternatif ise hidrolik silindirin motor-pompa ünitesinin sürücü ile hem yukarı hem de aşağı yönde hareketini sağlayan sistemdir.

Hidrolik asansörün makine dairesi genellikle zemin katta olacak şekilde projelendirilir. (Ancak binada istenilen katta makine dairesi olabilir. Kuyu + - 5 Mt.) Makine dairesinde, bir yağ kazanı (Tank) ve bunun üzerinde hidrolik sistem, kumanda panosu ve hidrolik sıvısının içinden geçtiği hortumlar bulunmaktadır.

Bu sistemde, asansör kuyusu içerisinde; asansör kabini, taşıyıcı karkas, silindir piston sistemi, askı tertibatı, tamponlar varsa karşı ağırlık tertibatı bulunmaktadır.

Hidrolik asansörler, yolcu ve yük taşımak için uygundur. Hidrolik asansörler, 2 ile 9 kat arasındaki yükseklikte 0.12 m/sn ile 1 m/sn hızlarında çalışabilir. Tek silindirli hidrolik asansörler, 240 kg ile 10.000 kg kadar ağırlığı, Çift silindirli hidrolik asansörler, 1500 kg ile 40.000 kg kadar ağırlığı taşıyabilirler.

Hidrolik asansörler düşük katlı binalarda kullanılır insan taşınmasından daha çok yük taşımada tercih edilir.

Hydraulic lifts are systems that provide the drive capability of the cabin with the movement of the piston by pushing or pulling the oil of the hydraulic pump unit driven by the electric motor.

In the generally used drive system, the upward movement of the motor-pump and the downward movement of the lift car's own weight are used.

Another alternative in the drive system is the system that provides both upward and downward movement of the hydraulic cylinder with the drive of the motor-pump unit.

The machine room of the hydraulic lift is usually designed to be on the ground floor. (However, there can be a machine room on any floor in the building. Well + - 5 Mt.) In the machine room, there is an oil boiler (tank) and hydraulic system, control panel and hoses through which the hydraulic fluid passes.

In this system, in the lift shaft; lift cabin, carrier carcass, cylinder piston system, suspension device, buffers, if any, counterweight device.

Hydraulic lifts are suitable for carrying passengers and cargo. Hydraulic lifts can operate at speeds of 0.12 m/sec to 1 m/sec at heights between 2 and 9 floors. Single cylinder hydraulic lifts can carry 240 kg to 10.000 kg weight, double cylinder hydraulic lifts can carry 1500 kg to 40.000 kg weight.

Hydraulic lifts are used in low-rise buildings and are preferred for load transport rather than human transport.

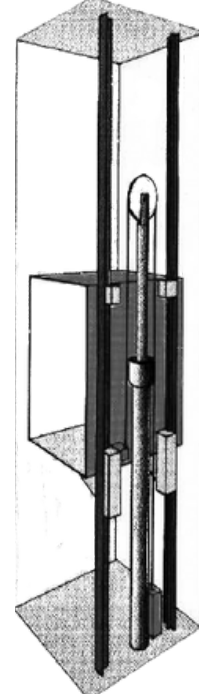
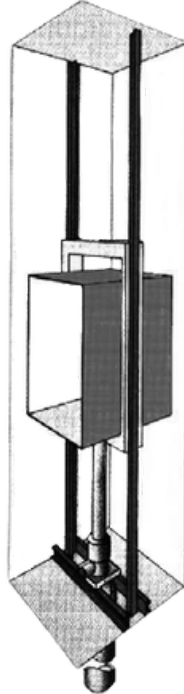
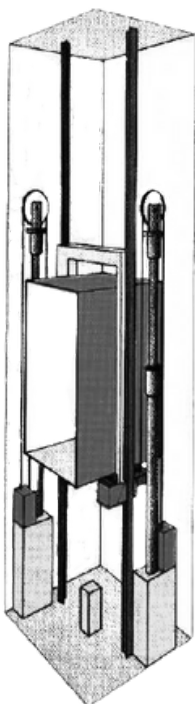

KOMPLE ASANSÖR SİSTEMLERİ

COMPLETE ELEVATOR SYSTEMS



SERVİS ASANSÖRLERİ

SERVICE ELEVATOR

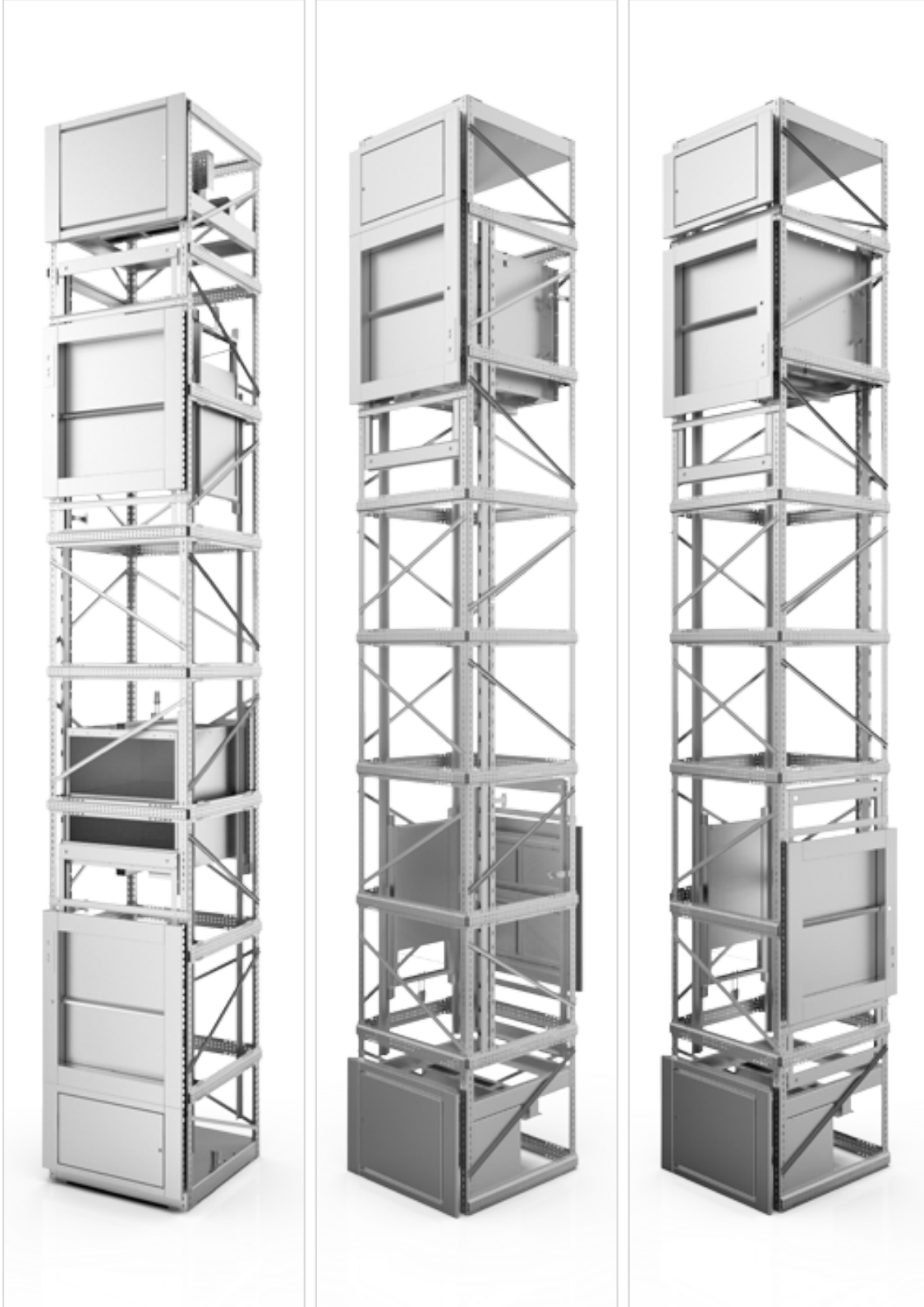

MCK 911

MCK 912

MCK 913

PROFESSIONAL ELEVATOR SOLUTIONS



GEMAK GEBZE MAKINE ELEKTRONIK ASANSOR SAN. VE TIC. LTD. STI.

Osman Yılmaz Mahallesi, Mehmet Akif Ersoy Cadde No:40 41400 Gebze/Kocaeli TURKIYE

Tel. : +90 (850) 25 900 25

Fax. : +90 (262) 646 60 20

E-Mail : info@gemak.biz

Web : www.gemak.biz